

# SERIES 1881 - SINGLE-POLE ROUND ROCKER SWITCHES

T0 12 (4) A 250 V AC



## PRODUCT FEATURES

- ◆ Attractive round rocker switch
- ◆ High mechanical rating with at least 100 000 switching cycles
- ◆ Variants with IP 51
- ◆ Low depth with 18.7 mm
- ◆ Appliance cut-out with 20 mm

## ON REQUEST













- ◆ Other colors
- ◆ Other printing variants
- ◆ Other connection variants (e.g. PCB)
- ◆ Cable assembly
- ◆ Gold-plated contacts for low voltages
- ◆ Changeover switch
- ◆ Painted variants

Mechanical life endurance	10E4
Operating force	3 N
Inrush current (capacitive)	70 A
Contact resistance (new condition)	< 100 mOhm (1 A 12 V DC)
Insulation resistance (new condition)	> 100 MOhm (500 V DC)
Voltage strength at 250 V	1 500 V function insulation / basic insulation 3 000 V reinforced insulation 500 V small contact distance
Proof tracking	250 PTI
Insulation spacing	acc. to EN 61058 for reinforced or double insulation
Protection type	IP 40 and IP 51 (product-dependent)
Ambient temperature	connection side -20 °C ... +100 °C actuating side -20 °C ... +55 °C
Flammability	UL 94 V-0 (product-dependent) UL 94 V-2
Heat and fire resistance	850 °C (category D)
Material	actuator PA housing PA connections silver-plated
Plug force of the terminals	≤ 80 N
Approval marks	/
Suitable for appliances of protection class II	



# SERIES 1881 - SINGLE-POLE ROUND ROCKER SWITCHES

TO 12 (4) A 250 V AC

	Actuator color / printing	Housing color	12 (4) A 250 V AC 1E4	8 (8) A 250 V AC 5E4	15 A 250 V AC 1 1/2 HP	15 A 125 V AC 3/4 HP	Connection type	Connection description	Contact distance in mm	Contact material	Actuator	EN 60335 cap. 30 conform "G"	Miscellaneous	Stock version
<b>ON/OFF switch (SPST)</b>														
1881.1103		Black	●	●	●	●		4.8	≈ 3	Ag	IP 40			●
1881.1104		Black	●	●	●	●		4.8	≈ 3	Ag	IP 40			●
1881.1105		White	●	●	●	●		4.8	≈ 3	Ag	IP 40			●
1881.1106		Black	●	●	●	●		4.8	≈ 3	Ag	IP 40	●		
1881.1108		Black	●	●	●	●		4.8	≈ 3	Ag	IP 51	●	with switching system cover	●
<b>Normally open contact (SPNO)</b>														
1881.1209		Black	●	●	●	●		4.8	≈ 3	Ag	IP 51		opening connection 1b closed with switching system cover	



Basic type 1881

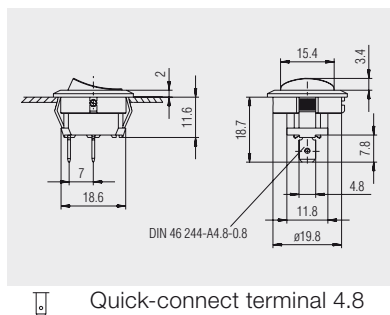

Quick-connect terminal 4.8

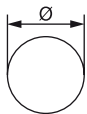

X = Wall thickness

X	Ø
0.75 ... 1.25	20.3
1.25 ... 2	20.8
2 ... 3	21.1

**PRECISION SALES INC**  
 38 Bishop Hollow Rd  
 Newtown Square PA 19073  
 www.precision-sales.com  
 eparts@precision-sales.com  
 Fax : 610-353-1674  
 610-359-1002